

# Product Guide

*Manufacturers*

*of Quality*

*Architectural*

*Fiberglass*

*Products*



**FIBERGLASS  
SPECIALTIES  
INCORPORATED**

[www.fsiweb.com](http://www.fsiweb.com)



# **Table of Contents**

Steeple	3-10
Steeple & Cupola Accessories	11
Cupola	12-14
Lighthouse	15
Domes	16
Finials	17
Steeple & Cupola Installation Guidelines	18-19
Baptistries	20-24
Baptistry Accessories	24-25
Baptistry Installation Guidelines	24
Baptistry Heaters	26-27
Optional Items	26
Wall & Roof Crosses	28

## **About the Company...**

Founded in 1963, Fiberglass Specialties was one of the first manufacturers of fiberglass church baptistries, steeples, and wall crosses. Today we are the market leader, with the largest line of products in the industry. Our strong desire to improve our products and better serve our customers are the driving forces behind our constant innovation.

Fiberglass Specialties is a family owned business, now in its second generation. Owner and President Rocky Hall takes a hands-on approach not unlike that of his father, Howard Hall, who began the company over forty-five years ago.

We invite you to visit our 65,000 square foot manufacturing and office facility and see for yourself why Fiberglass Specialties is a name you can trust.

**RULE OF THUMB**—Architects generally select a steeple that is about the same height as the distance from the ground to the peak of the roof of the building.

NOTE: All measurements, weights, and drawings shown in the catalog are rounded off and approximate.

## Design Purpose:

**T Models** - An off-set tank to provide more room for baptism!

**S Models** - The perfect blend of size and economy!

**R Models** - Perhaps our most beautiful baptistries are Round!

**V Models** - Select your own entry angle!

**EZ Models** - Allows the minister to remain dry!

**LG Models** - Largest baptism tank!

**M Models** - "Modular" - Create your own design!

**Mini Models** - For limited space!

**EZ-P Models** - Portable!

## Compare...

- ✓ A unique, patented\* new design style features more generous step treads for improved safety and comfort. (All Baptistry steps were designed with 11" treads 7" risers as required by National Model Building codes such as BOCA, SBCCA, UBC and the 2000 International Building Code).
- ✓ The steps flow into the tank area, creating a built in child's step within the tank area.
- ✓ Step treads feature a "raised circular disk" pattern widely used in commercial applications. This pattern provides a high level of slip resistance and offers easy cleaning.
- ✓ The overall design concept of all Series 2000 baptistries maximizes usable space and minimizes wasted space. This approach conserves water, and reduces costs associated with heating the water.

\*U.S. Patent Number 5,790,990

## "T" Model Baptistries

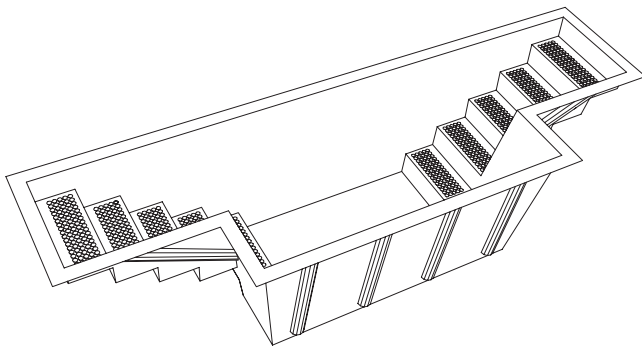

One of our most popular styles, these double entry baptistries feature an offset tank to provide more room for the baptism. As with all Series 2000 baptistries, the steps flow into the tank area, providing a more comfortable entrance and exit.

The T2 is available in three sizes as shown below. The T2S and T2M are 3'6" deep, and the T2L is 4'0" deep. All WF and WB styles feature a 12" viewing window as shown.

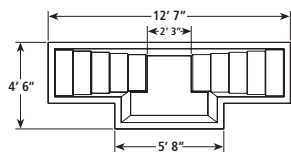

T2S

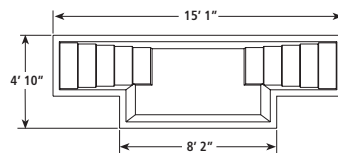

T2M

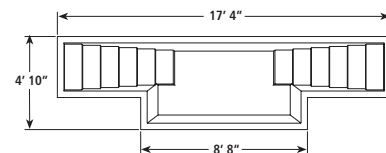

T2L

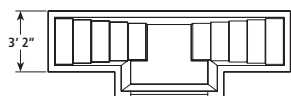

T2S-WF

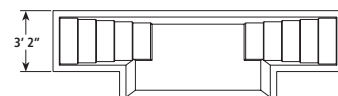

T2M-WF

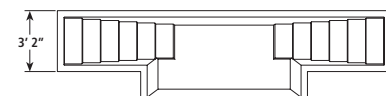

T2L-WF

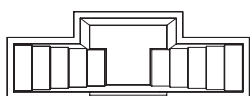

T2S-WB

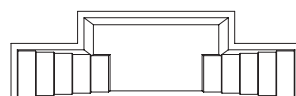

T2M-WB

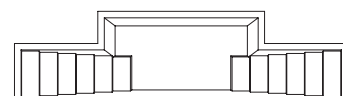

T2L-WB

**T2S Models:**  
Height: 3' 6" inside  
Shipping weight: 290 lbs  
Capacity: 550 gal.

**T2M Models:**  
Height: 3' 6" inside  
Shipping weight: 385 lbs  
Capacity: 800 gal.

**T2L Models:**  
Height: 4' 0" inside  
Shipping weight: 460 lbs  
Capacity: 1050 gal.

## "S" Model Baptistries

Choose from double or single entry models

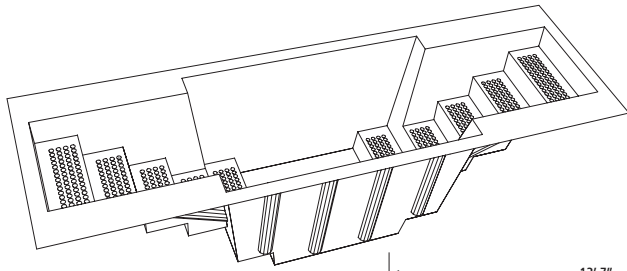

These simple, yet versatile baptistries are the perfect blend of size and economy.

All "S" Models are 3' 6" deep.

Models designated with "W" feature a 12" tall viewing window.

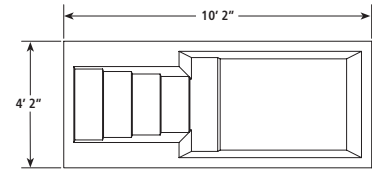
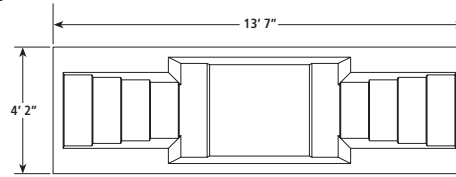

S2

S1

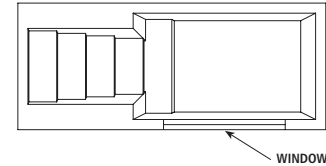

S1-WL  
Left Entry  
Window Right

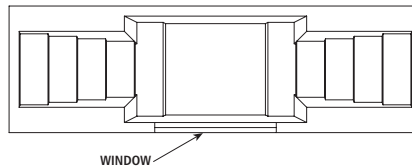

S2-W

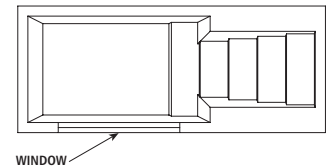

S1-WR  
Right Entry  
Window Left

S2 Models:  
Height: 3' 6" inside  
Shipping weight: 335 lbs  
Capacity: 690 gal.

S1 Models:  
Height: 3' 6" inside  
Shipping weight: 274 lbs  
Capacity: 590 gal.

## "EZ" Model Baptistries

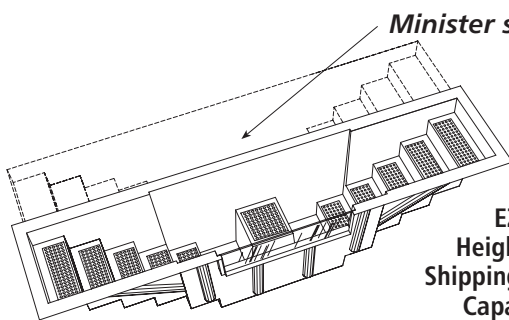

Minister stays dry behind baptistry

EZ2 Models:  
Height: 3' 6" inside  
Shipping weight: 315 lbs  
Capacity: 465 gal.

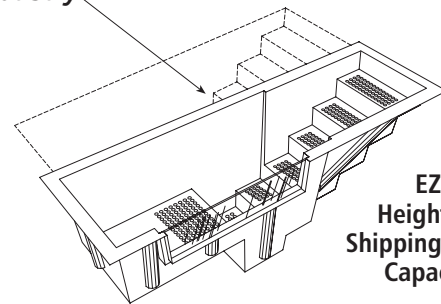

EZ1 Models:  
Height: 3' 6" inside  
Shipping weight: 230 lbs  
Capacity: 350 gal.

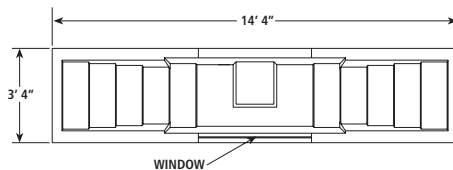

EZ2-W

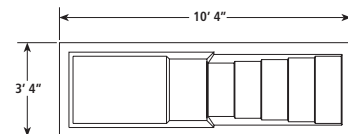

EZ1

EZ Models are easier because they allow the minister to remain dry—outside the baptistry—during the baptism.

The candidate is baptized from a seated position on a molded in platform, making the process easier than with conventional baptistries.

As with all Series 2000 baptistries, the EZ Models feature wider, more comfortable steps for a safer, more relaxed entry.

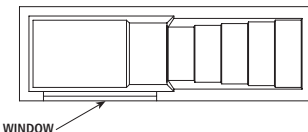

EZ1-WR  
Right Entry  
Window Left

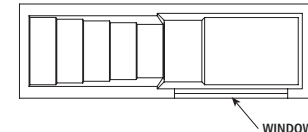

EZ1-WL  
Left Entry  
Window Right

### Baptistries are available in 4 standard colors...

Choose any of our four standard colors: *Blue* (our most popular), *Aqua* (a soft blue-green mix), *Bone* (light tan), or *White*. Custom match colors are also available.



# Series 2000 Baptistries

All prices are FOB Henderson, Texas  
Please call for freight rates

## "R" Model Baptistries

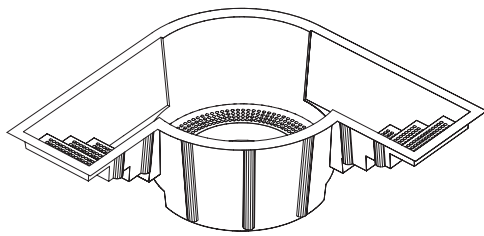

*The degree of angle may be varied to meet your requirements.*

Perhaps the most beautiful baptistries, these round models offer the same comfortable, code designed step treads as all our Series 2000 models.

The steps flow into the tank, creating a built-in child's step.

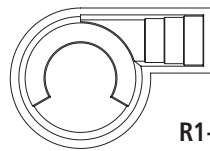

R1-R



R1-C

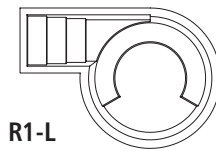

R1-L

R1 Models:  
Height: 3' 6" inside  
Shipping weight: 395 lbs  
Capacity: 715 gal.

R2 Models:  
Height: 3' 6" inside  
Shipping weight: 460 lbs  
Capacity: 850 gal.

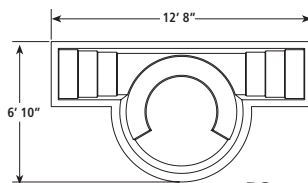

R2

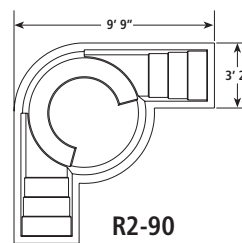

R2-90

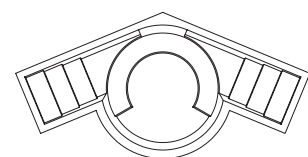

R2-45

## "V" Model Baptistries

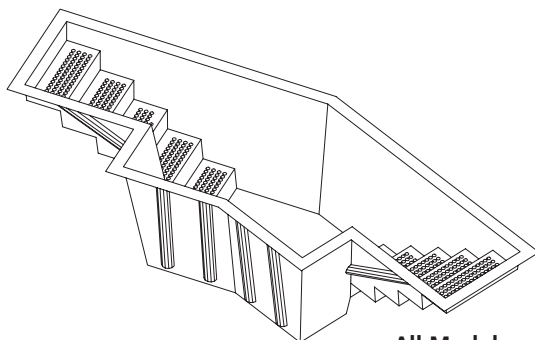

Window option not available

All Models

V-S2

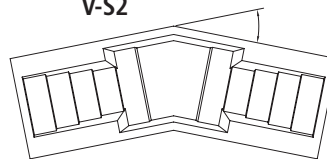

V-T2M

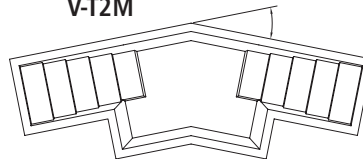

*Specify degree of angle.*

"V" Models are customized from most of our double entry models except EZ Series.

The angle may be varied to meet your design requirements.

## "Mini" Model Baptistries

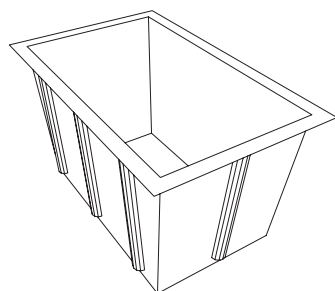

MINI  
(Baptistry only)  
Optional window

The "Mini" baptistry was designed for churches who have very limited space, but want a built-in baptistry.

Just large enough for two people, the "Mini" can be installed below the stage and covered with 4' x 8' platform.

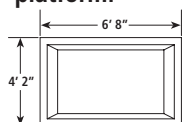

Height: 3' 6" inside  
Shipping weight: 215 lbs  
Capacity: 490 gal.

With no room for steps, the "Mini" was designed to be used with our "Handi-Step" removable stepladder system.

The "Handi-Step" is a removable stepladder system that can be used with our "Mini" or "MX" baptistries.

The sloped steps and angled handrail make this system safe to use and suitable for the elderly or infirm.



HS-1  
Shipping weight: 60 lbs

## "M" Model Baptistries

The "M" is for "modular"; with these models, you create your own design!

Pick

a model shown below, or use the diagram to create your own unique style.

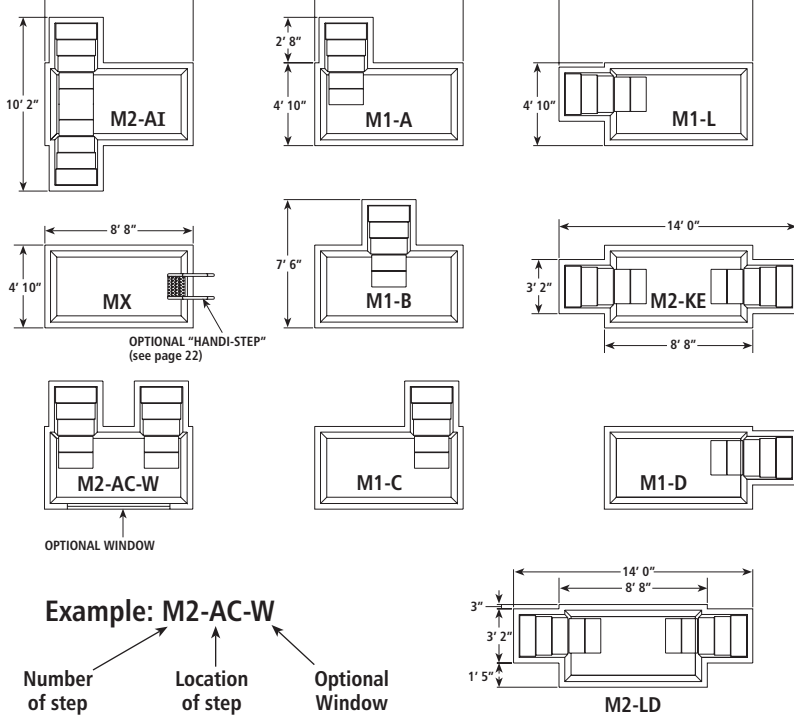

**Example: M2-AC-W**

Number of step entries

Location of step entries

Optional Window

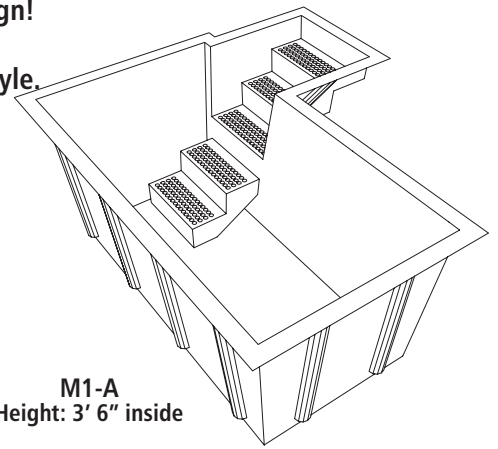

**M1-A**  
Height: 3' 6" inside

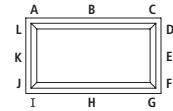

**Step Entry Location Diagram**

	<u>Ship Weight</u>	<u>Capacity</u>
MX Models (No Steps)	285 lbs	705 gal.
M1 Models (Single Entry)	350 lbs	750 gal.
M2 Models (Double Entry)	415 lbs	795 gal.

Optional Window (All Models)

Windows are located as shown on M2-AC-W model. Please specify if you wish a different location.

## NEW! "LG" Model Baptistries

FSI's new "LG" Series pool has an extra large tank area for the baptism. It's perfect for witnesses or family baptism.

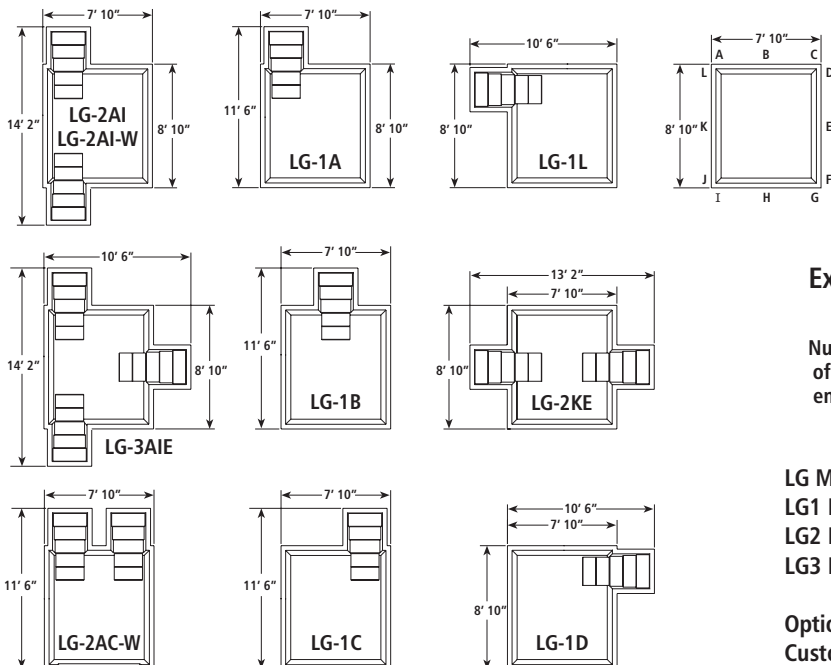

**Step Entry Location Diagram**

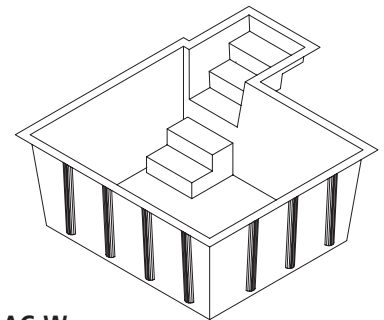

**Example: LG2-AC-W**

Number of step entries

Location of step entries

Optional Window

	<u>Ship Weight</u>	<u>Capacity</u>
LG Models	315 lbs	1185 gal.
LG1 Models	379 lbs	1230 gal.
LG2 Models	444 lbs	1275 gal.
LG3 Models	509 lbs	1320 gal.

Optional Window: 6' Long Side  
Customer to specify window location

# Series 2000 Baptistries

All prices are FOB Henderson, Texas  
Please call for freight rates

## Portable Baptistry

EZ-P Model:  
Height: 3' 0" inside  
Shipping weight: 230 lbs  
Capacity: 100 gal.

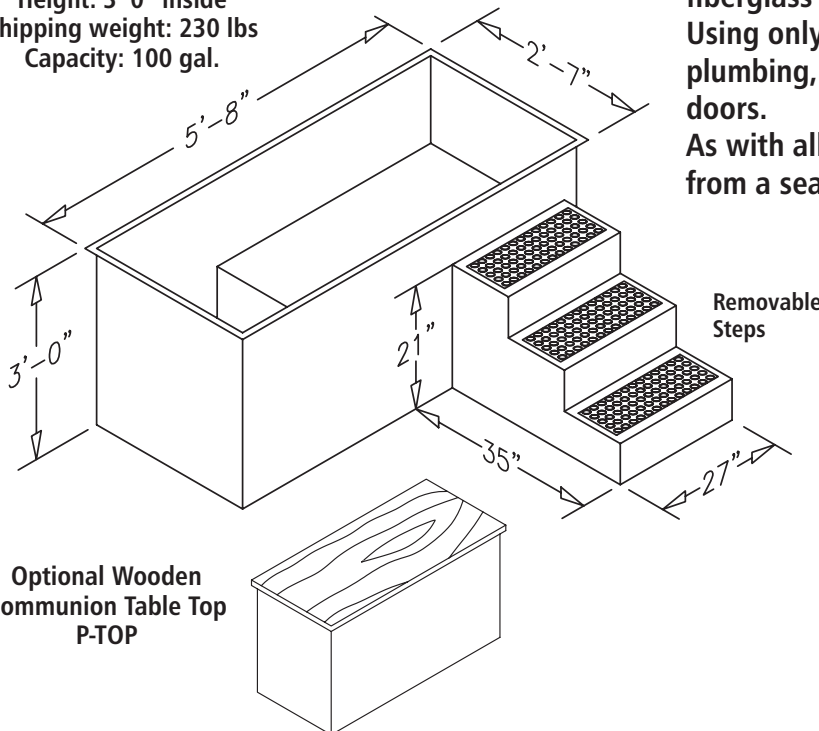

This freestanding portable unit is finished, molded fiberglass inside and out. Using only 100 gallons of water, it requires no plumbing, and is small enough to fit through most doors. As with all EZ models, the candidate is baptized from a seated position.

**Portable Pools and Heater in Stock!**

## NEW! Portable Heater



Perfect for portable, movable, and small in-place pools.

This new heater can fill, drain, circulate, and heat from either a 120v or 240v power source. With built in GFCI protection this unit will heat much faster and is safer to use than traditional Over the Side heaters. It is the only portable heater that is UL listed for use in baptismal pools.

EQAS P-120 = 1000 watt/120v (15 amp/120v)  
EQAS P-240 = 4000 watt/240v (30 amp/240v)

**No holes to drill ! Ready to heat !**



### Our steps are safer...

The steps leading in and out of our Series 2000 Baptistries are wider and less steep than other baptistries, making entrance and exit easier and more comfortable. The 7" rise and 11" step conforms to national building codes.

# Baptistry Accessories

All prices are FOB Henderson, Texas  
Please call for freight rates

## Drip Landings

Place these fiberglass landings at the top of your baptistry steps to catch dripping water from wet robes.

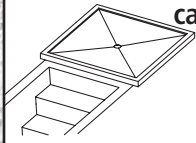

#ACC-140  
3'-9" square

#ACC-145  
3'-3" square

## Child's Step

Removable step raises short children 12" for visibility. Includes toe-hold bar and suction cups for attachment.

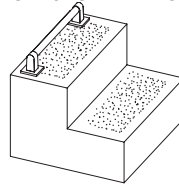

#ACC-130

## Seat / Platform

This versatile accessory can be used as a step for children or as a seat for adults. Includes toe-hold bar and suction cups for attachment.

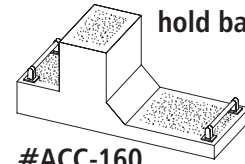

#ACC-160

## Baptistry Installation

Shown here is a typical baptistry installation. Details may vary from building to building. In general, all baptistries should be supported underneath with a flat surface, and framed in at the top lip with stud walls.

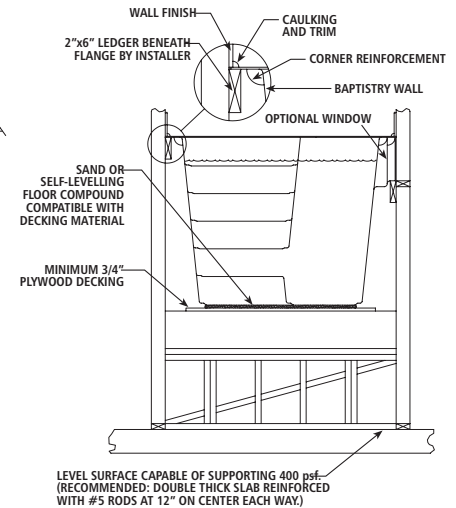
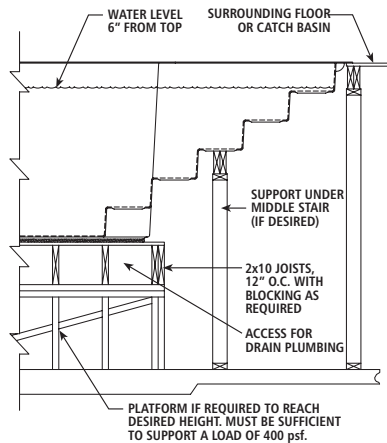

## AquaGuard Finish

Our standard baptistries are made with the highest quality and finish available in the industry. To preserve this finish we recommend that the baptistry be drained after each use and left empty until needed. Leaving water standing in the baptistry for extended periods may damage the gel-coat surface.

For those churches who plan to leave the baptistry filled for extended periods, we recommend our "AquaGuard" finish option. This special process provides an extra level of protection against blistering and spotting caused by prolonged water contact.

We guarantee baptistries purchased with the AquaGuard Finish option against surface blistering, peeling, or cracking for five (5) years when installed and maintained according to instructions.

## Optional Window

Available as an option on most baptistries, this 12" tall acrylic window allows better viewing of the baptism. This is especially helpful if the baptistry is elevated above ground level.

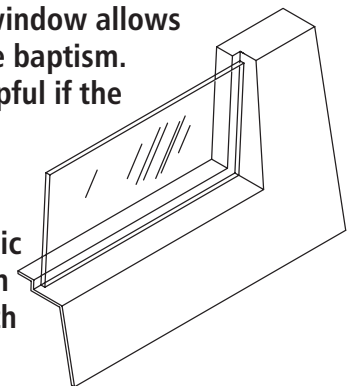

The sturdy 1/2" acrylic window is shipped in protective paper, with silicone sealant for installation by your contractor. We recommend installing the window last, to prevent possible damage.

Series 2000 baptistries feature an improved window system, making installation practically foolproof.



# Baptistry Heaters

All prices are FOB Henderson, Texas  
Please call for freight rates

## EQAS Baptistry Heater

Efficient, Quiet, Affordable, & Safe. That's what EQAS means to our customers. It's easy to install using factory wired, plug together connectors for the pump and the optional EQAS 2000 Autofill device. An air button (included) can be mounted top side on the pool to control the on-off operation of the heater if the customer wishes.

Standard features include a built in Ground Fault Circuit Interrupter, Time Clock, and Thermostat. The unit is manufactured using all UL Registered parts and an ETL listing. The heater, pump, and all necessary fittings, including a mounting base, are delivered in one box. Heater also operates on 208V with reduced efficiency.



Electrical requirements:  
H-5 = 2 pole, 40 amp  
H-5 + Booster = 2 pole 60 amp  
Heater size (with pump installed)  
16" tall, 24" wide, 16" deep



H-5  
Shown

## Optional Items

### Deck Mounted Manual Fill Faucet

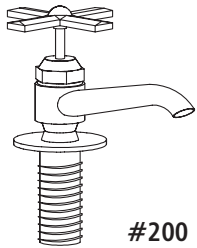

Chrome plated, single valve faucet. Can be easily mounted at any desired location on rim. For 1/2" connections.

#200

### Flush Port Manual Fill Valve

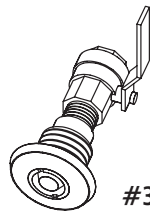

Attractive flush port with brass fill valve, operated from behind the baptistry. Uses 3/4" connections.

#300

### EQAS 2000 Autofill

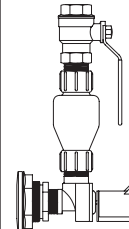

Turn this unit on, and an electric fill valve opens to fill the baptistry, then closes when the baptistry is full. If left on, system will cycle on and off to maintain proper water level.

#2000

### Manual Drain Unit

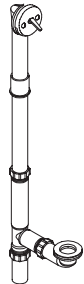

Our most economical drain system, this unit includes chrome plated fittings, an overflow with a mechanical trip lever, and all necessary fittings for installation.

#172 for 3'-6' baptistries #172B for 4' baptistries

### Deluxe Manual Drain

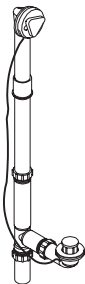

Unique "Free Flow" design uses an external cable linkage. Highest quality machined fittings assure positive seal to prevent seepage. Drain is activated by an attractive rotating knob on the overflow.

#185 for 3'-6' baptistries #185B for 4' baptistries

### Filter/Skimmer



Designed for use with our H or S series heating systems. Washable filter insert.

FILTER

## Heater Packages

**ECONOMY SYSTEM**  
H-5 Heater  
200 Surface Fill Faucet  
172 Manual Drain

**STANDARD SYSTEM**  
H-5 Heater  
300 Flush Fill Port  
185 Manual Drain

**DELUXE SYSTEM**  
H-5 Heater  
EQAS 2000 Autofill  
185 Manual Drain

For larger pools or faster heating, add the EQAS Booster Pack!

# Baptistry Heaters

All prices are FOB Henderson, Texas  
Please call for freight rates

## EQAS Automatic Baptistry Heating System



S-5 + Booster Shown

Electrical requirements:  
S-5 = 2 pole, 40 amp  
S-5 + Booster = 2 pole 60 amp  
Heater size (with pump installed)  
16" tall, 24" wide, 16" deep



Heater  
Auto Fill  
Auto Drain  
Plug-In Options



Our "S Series" EQAS heaters have all the features of our "H Series" heaters, but add the convenience of fully automatic control. This system allows for automatic fill, automatic water level control, and automatic drain. From the front of the unit or from poolside, the on/off and fill/drain functions can be initiated. Temperature and Time Clock settings are easily pre-set on the front of the heater. Heater, pump, controllers, wiring, and all necessary fittings are shipped in one box.

EQAS S-5: 5.5kw heater with automatic control system  
EQAS S-5 + Booster: 11kw heater with automatic control system  
NOTE: System can operate on 208-volt with reduced efficiency

## EQAS Booster Pack

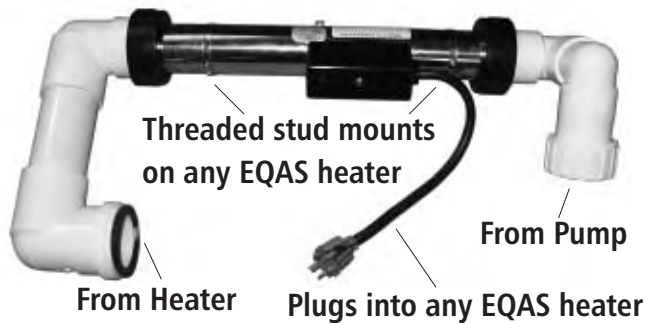

For use with larger pools or for those that just want to heat their pools faster, the EQAS booster pack is easy to add to any EQAS H-5 or S-5 heater order. The Booster Pack easily attaches to any EQAS heater. No need to run a second power line, the Booster Pack plugs into any EQAS heater! The combination of the EQAS heater and Booster Pack requires a 2P/60 amp circuit breaker and appropriate sized wiring from the breaker box to the heater. The GFCI protection built into all EQAS heaters is rated for 60 amps.

## Optional Items

### Optional Secondary Heater



EQAS OSH

For larger baptismal pools (like the LG) or for those that just want to heat the water faster, our Remote Heater is the perfect answer. This 11kw heater comes with its own separate heater and pump. It plugs into any S Series product for single location control of temperature and operation. As with all EQAS heaters, the GFCI is built in.  
NOTE: Requires separate 60 amp/240V circuit.

### Remote Controller

EQAS Remote



For situations where the heater may be difficult to access for temperature control, this is the perfect solution. Our Remote Controller can be mounted in any wall and allows for full operation of on/off, fill/drain, and temperature control. A digital read out displays the temperature of the baptismal pool water.

This system replaces FSI's AT-55 or CZ-11 and COM-1 products.